

FORNOVOGAS **50**
WE MOVE ENERGY YEARS 

DA300 OIL FREE

RECIPROCATING COMPRESSOR

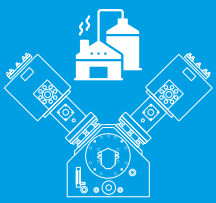
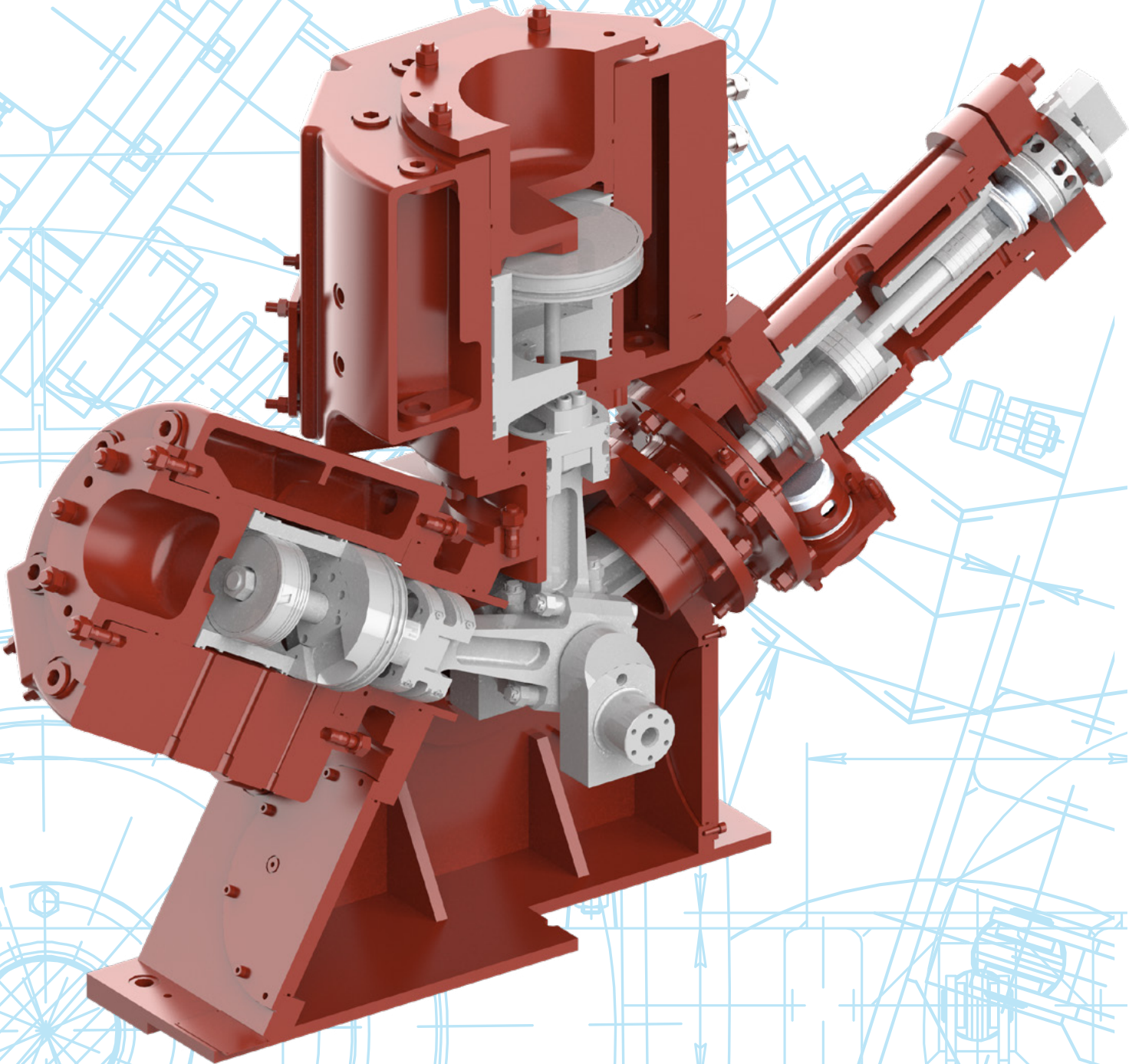

BIOGAS

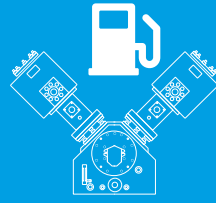

CNG

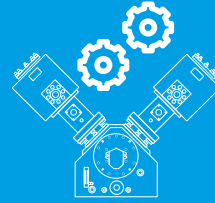

INDUSTRY

MADE IN ITALY 

DA300 OIL FREE

POWER OUTPUT UP TO 400 kW

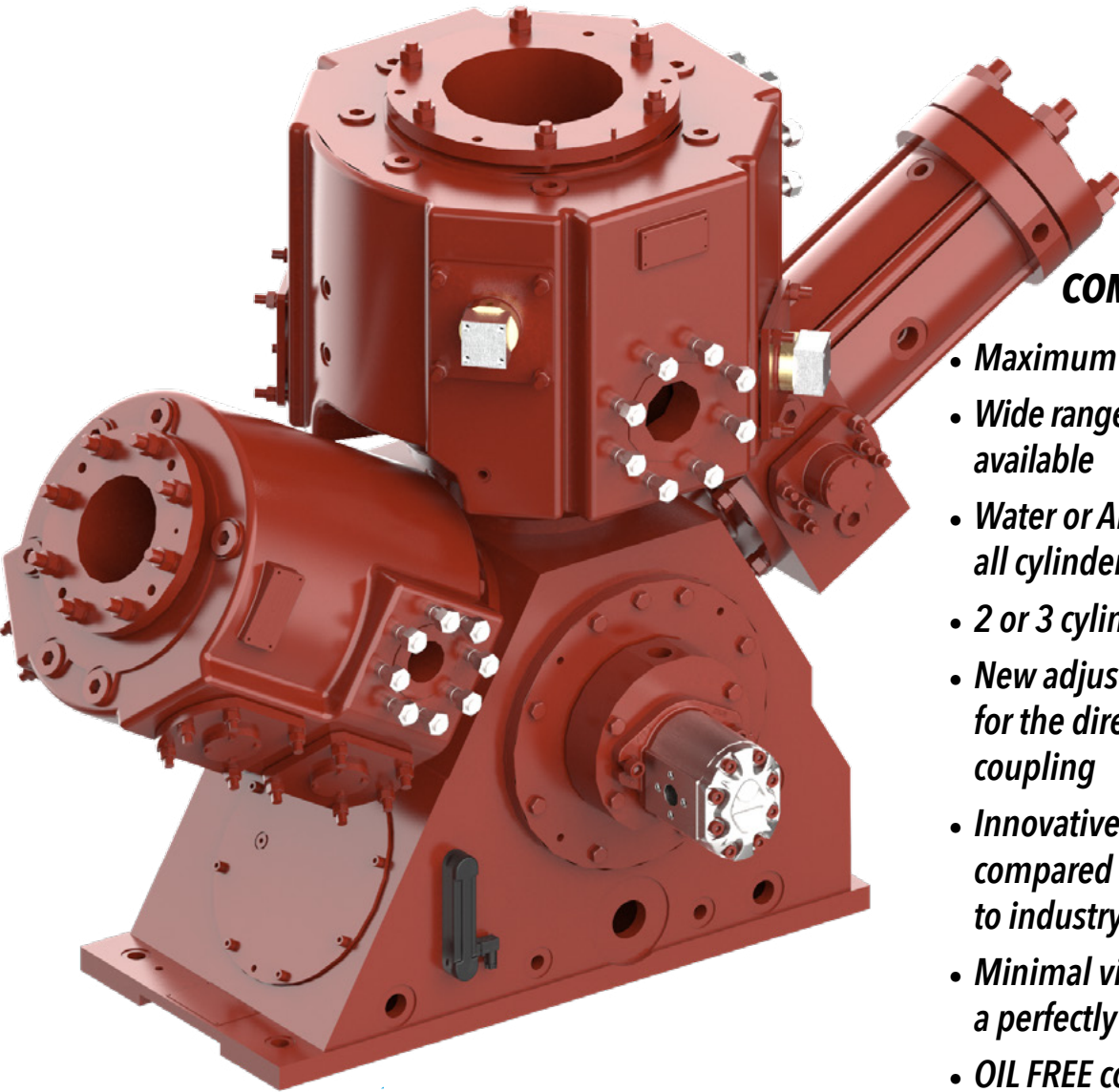

COMPRESSOR FEATURES

- *Maximum speed: 1800 rpm*
- *Wide range of cylinders and bores available*
- *Water or Air-cooling capabilities on all cylinders*
- *2 or 3 cylinders configuration*
- *New adjustment system for the direct motor-compressor coupling*
- *Innovative pistons and seals compared to industry standards*
- *Minimal vibration thanks to a perfectly balanced compressor*
- *OIL FREE configuration*

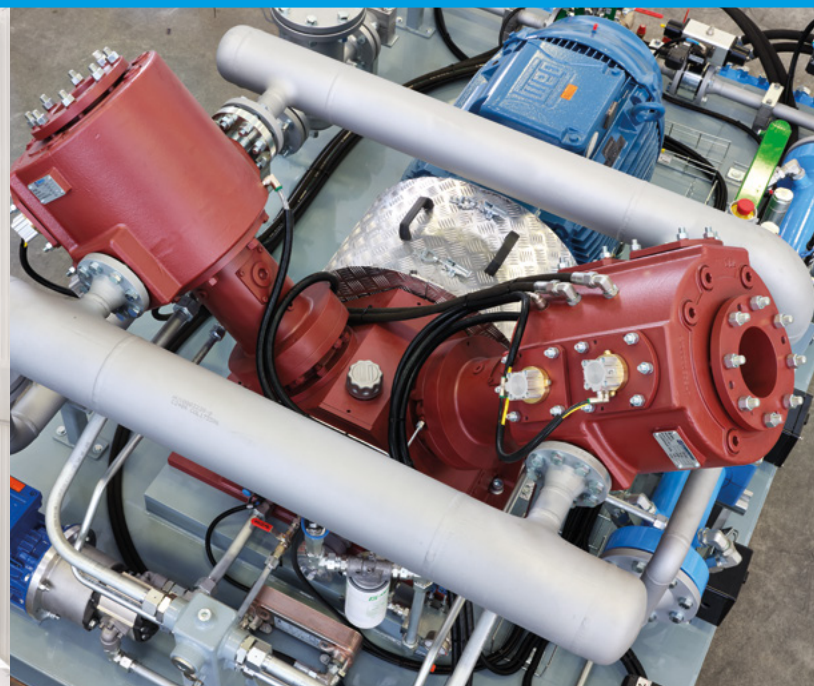

OUR SERVICE



We are able to do **24/7 service** with our specialists, worldwide.

We guarantee performance on our compressors using original spare parts.

We can be your reliable service partner

- **Quality and safety**
- **Efficiency**
- **Expertise**

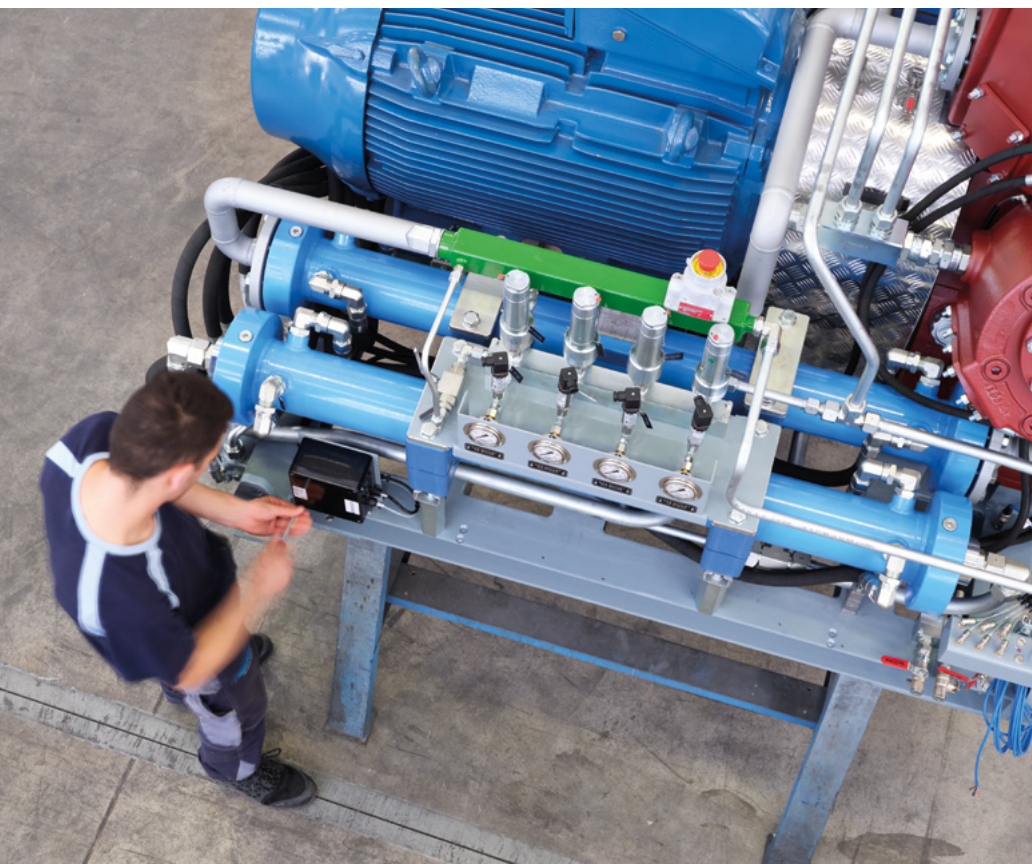

OUR ACTIVITIES

- **Start-up services**
- **Spare parts**
- **Repairs and overhauls**
- **Inspections and maintenance**
- **Testing and monitoring**
- **Consulting and training**



FORNOVOGAS **50**
WE MOVE ENERGY YEARS 



FORNOVOGAS S.p.A.
Sede legale e operativa
Via Ponticelli, 5-7, 43029 Traversetolo (PR) - Italia
Tel +39 0521 1553844 Fax +39 0521 1523066
info@fornovogas.it

WWW.FORNOVOGAS.IT